

**BATTERY MANUFACTURER
WORLDWIDE TECH SUPPORT**

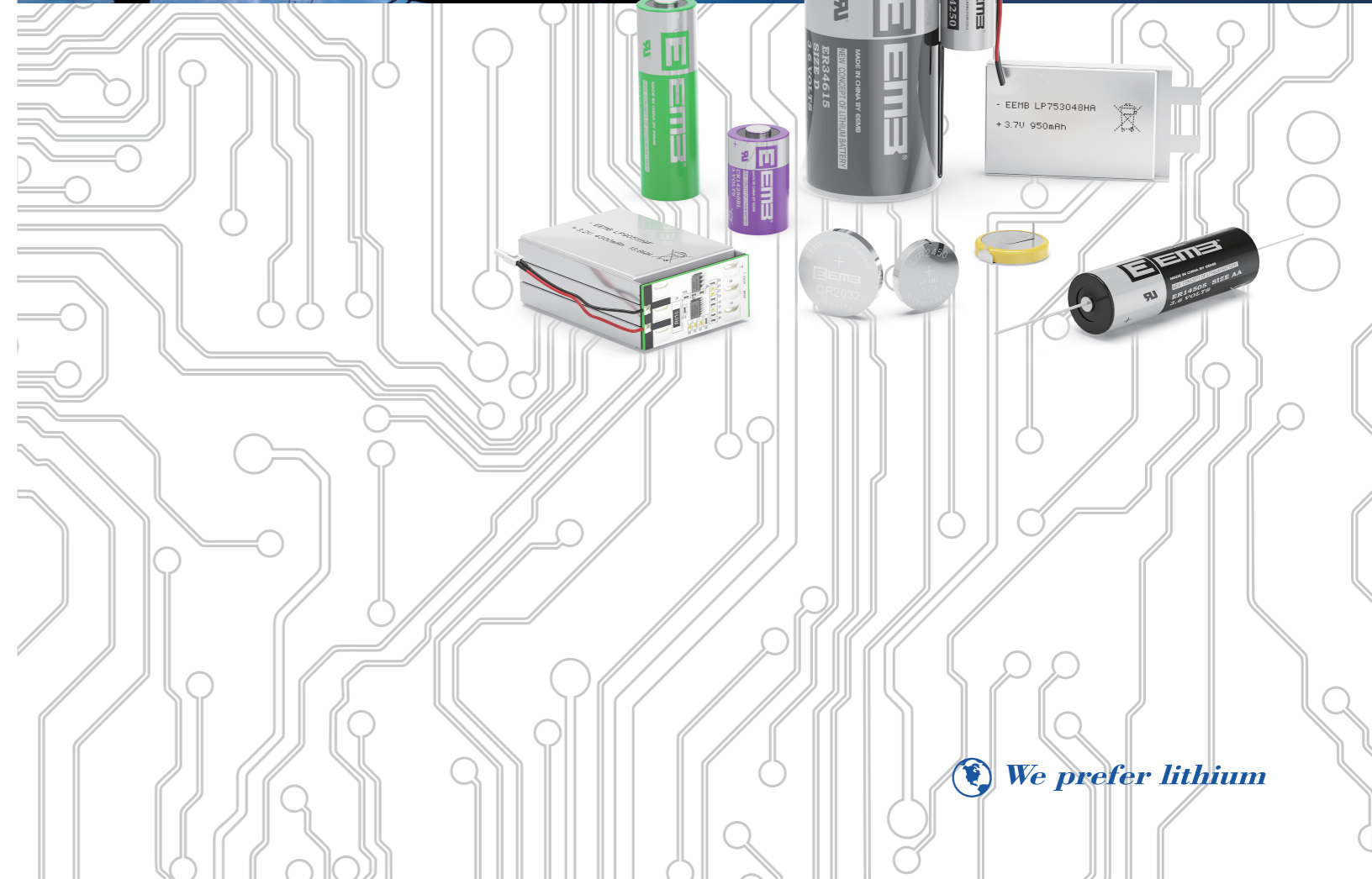

LITHIUM BATTERY

Tel: +86-755-22225375 E-mail: global@eemb.com

<https://www.eemb.com>



 *We prefer lithium*

CONTENTS



Company Profile

EEMB Battery

EEMB specializes in the production of Primary Lithium Battery and Rechargeable Lithium Battery since 1995. Because of our strong sales network and great customer service in the industry, our products have reached world wide.

Our company emphasizes the application of the latest technology and systematic management. We are dedicated to providing products and service up to and beyond customers' expectation in a timely and reliable manner.

Our highly qualified staff, modernized management, and international sales concept are the core of the company. We firmly believe in letting our employees self-manage and everyone's contribution will be highly valued. The idea of "Quality, Innovation, Sincerity and Service" runs through the enterprise culture.

Li-SOCl ₂ Battery	1~3
Li-MnO ₂ Battery	4~8
Li-Polymer Battery	9~13
LiFePO ₄ Battery	14~16
Li-ion Battery	17~19
Terminals	20~22
Battery Holder	23



Li-SOCl₂ Battery Energy & Battery with Hybrid Design

Cell Constructions

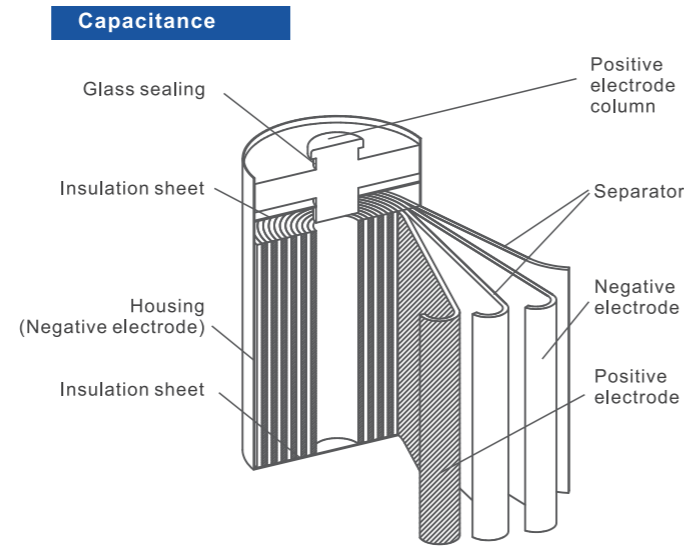
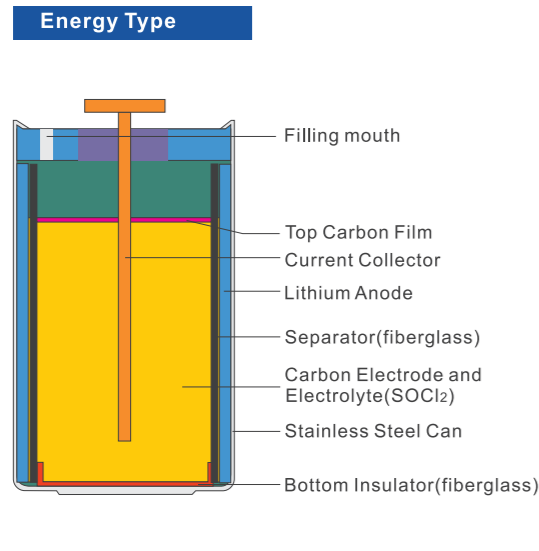

Main Features

- ▶ Wide Temperature Range.
- ▶ Superior Shelf Life and Reliability: over 15 years at room temperature and self-discharge rate is less than 1% of its nominal capacity per year.
- ▶ Energy type is bobbin structure and best suit for low current discharge. It may require depassivation before medium currents can be delivered.
- ▶ High power type is spiral structure and best suit for high current discharge for both continuous & pulse currents. It may require depassivation before medium currents can be delivered.

Applications

- ✓ Medical Instruments, Cash Registers
- ✓ Alarms and security wireless devices
- ✓ Tracking devices
- ✓ Electronic Meters (Water, Gas, Electricity)
- ✓ Automotive telematics
- ✓ Professional electronics
- ✓ Marine / oceanographic equipment
- ✓ IOT solutions

Energy Type(Cylindrical)

Model	Size	Nominal Voltage (V)	Nominal Capacity (mAh)	Standard Discharge Current (mA)	Max. Discharge Current(mA)		Dimension (mm)		Approx. Weight(g)
					Conts.	Pulse	Diameter	Height	
ER10250	—	3.6	400	0.5	5	10	10.4	25.0	4.0
ER10450	AAA	3.6	800	0.5	25	60	10.6	45.0	9.0
ER14250	1/2AA	3.6	1200	0.5	20	50	14.5	25.2	11.0
ER14335	2/3AA	3.6	1650	1.3	30	70	14.5	33.5	13.0
ER14505	AA	3.6	2600	1.0	50	100	14.5	50.5	19.0
ER17335	2/3A	3.6	2100	1.0	50	100	17.0	33.5	20.0
ER17505	A	3.6	3600	1.0	70	150	17.0	50.5	24.0
ER18505	—	3.6	4100	2.0	80	150	18.5	50.5	29.0
ER20505	—	3.6	4400	1.2	120	250	20.0	50.5	35.0
ER26500	C	3.6	9000	3.0	100	200	26.2	50.0	53.0
ER34615	D	3.6	19000	3.0	150	300	32.9	61.5	105.0
ER341245	DD	3.6	35000	3.0	200	400	34.2	124.5	200.0
ER9V	—	10.8	1200	0.5	40	80	16.9x26.3x48.6		40.0

Energy Type(Button)

ER2450	—	3.6	500	0.5	8.0	20	24.5	6.2	9.0
--------	---	-----	-----	-----	-----	----	------	-----	-----

Battery with Hybrid Design

Model	Nominal Voltage (V)	Nominal Capacity (mAh)	Max. Discharge Current(mA)	Dimension (mm)	Weight(g)
			Pulse		
ER14250+HR14250	3.6	1200	2600	15*30*27	23
ER14505+HR14250	3.6	2700	2600	15*30*55	31
ER18505+HR14250	3.6	4000	2600	18.5*34*55	44
ER26500+HR14250	3.6	9000	2600	28*44*55	65
ER34615+HR14250	3.6	19000	2600	35*50*64	115
ER14250+HR14505	3.6	1200	4000	15*30*55	35
ER14505+HR14505	3.6	2700	4000	15*30*55	41
ER18505+HR14505	3.6	4000	4000	18.5*34*55	54
ER26500+HR14505	3.6	9000	4000	28*44*55	75
ER34615+HR14505	3.6	19000	4000	35*50*64	130

Features: Lithium-Thionyl Chloride Battery with high-capacity and low self-discharge rate and HR composite capacitor which is capable of instantaneous high-current discharge are connected in parallel, suitable for long-term low-power standby, ideal power supply for instantaneous high-current pulse discharge equipment. Full-sealed structure design makes it adapted to harsh environments and long working years, perfect for IoT power needs.

Operation Temperature: -55 ~ + 85°C, Self-Discharge Rate: < 2%/year at room temperature.

Electrical Performance Curve

Energy Type

(For ER14250 Typical)

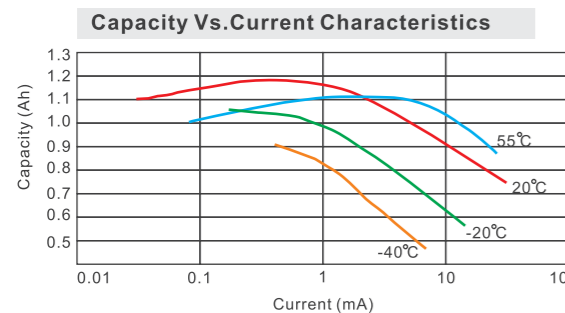
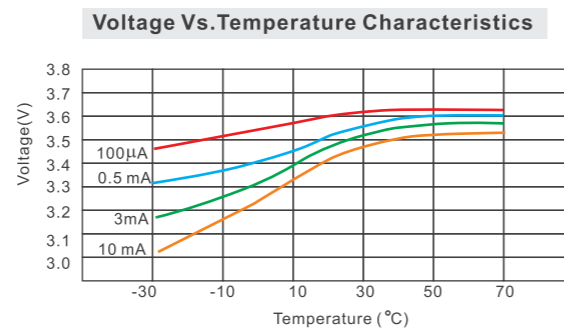
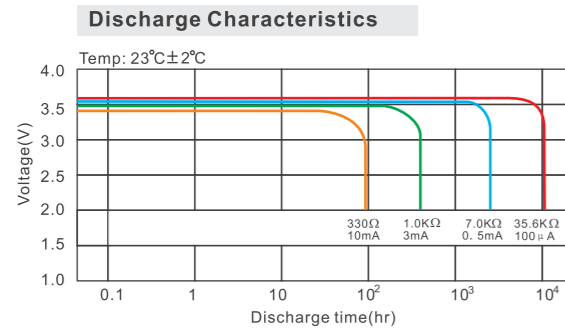

Discharge Characteristics

High Power Type

(For ER14505+HR14250)

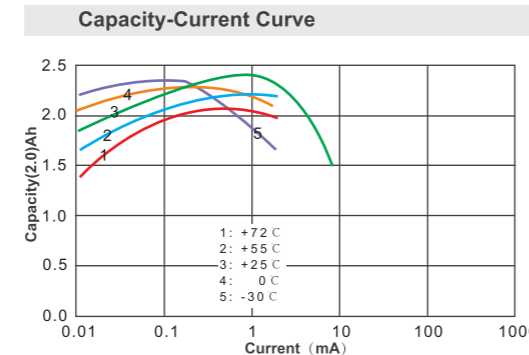
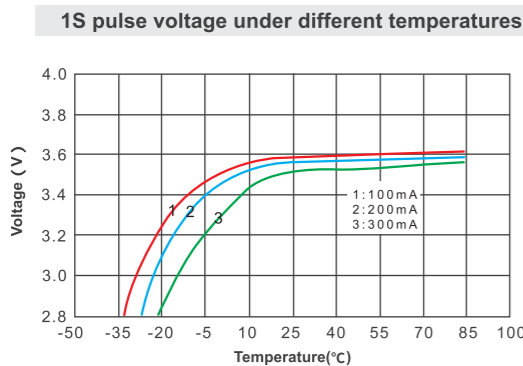
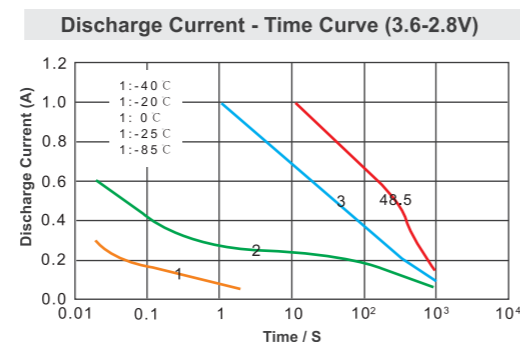
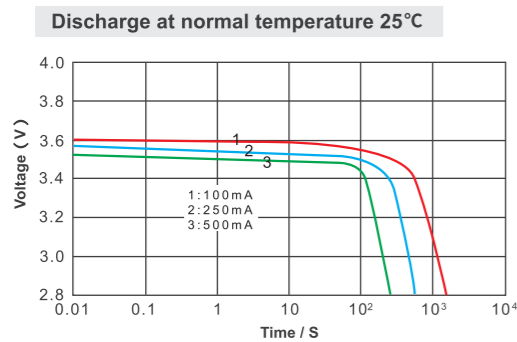

Li-MnO₂ Cylindrical Battery

Cell Constructions (Hermetically Glass to Metal Sealed)

High Power Type

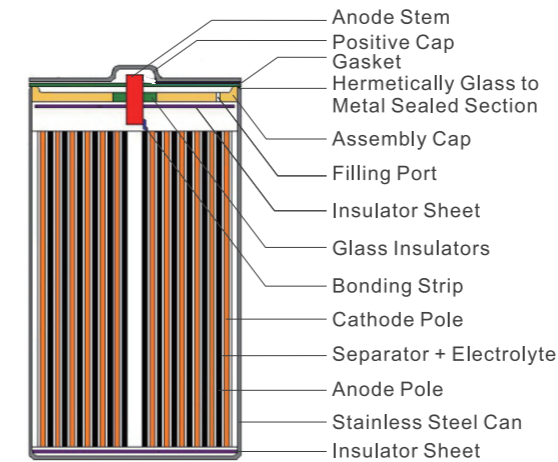

High Capacity Type

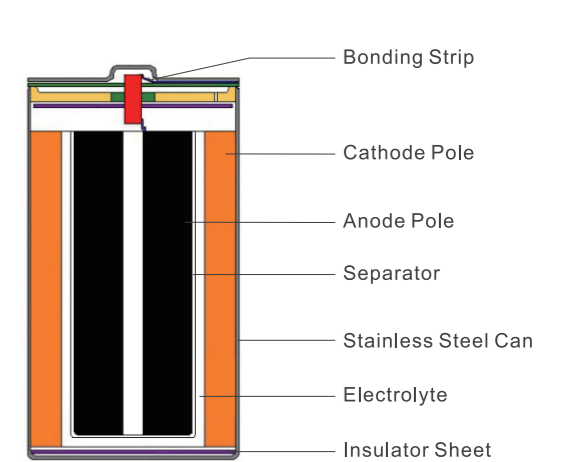

Main Features

- High power type for high current discharge & High capacity type for low current discharge.
- Low self-discharge rate and long shelf life.
- Stable discharge characteristics.
- Superior leakage resistance.

Applications

- Electronic locks
- DSC, Lighting, Radios
- Water, gas and electricity meters
- Main power sources and memory backup power sources for car electronics
- Memory backup power sources for office and factory automation equipment
- Medical equipment
- Fully automatic cameras



High Power Spiral Structure

Model	Size	Nominal Voltage (V)	Nominal Capacity (mAh)	Standard Discharge Current (mA)	Max. Discharge Current (mA)		Dimension (mm)		Approx. Weight (g)
					Conts.	Pulse	Diameter	Height	
CR14250SL	1/2AA	3.0	600	1.0	500	1000	14.5	25.0	10.0
CR14335SL	2/3AA	3.0	900	1.0	800	1500	14.5	33.5	14.0
CR14505SL	AA	3.0	1500	1.0	1000	2000	14.5	50.5	21.0
CR2SL	—	3.0	800	1.0	800	1500	15.5	27.0	13.0
CR17335SL	2/3A	3.0	1500	1.0	1500	3000	17.0	34.5	20.0
CR17450SL	—	3.0	2200	1.0	1500	3000	17.0	45.0	26.0
CR17505SL	A	3.0	2500	1.0	1500	3000	17.0	50.5	30.0
CR18505SL	—	3.0	2800	1.0	1500	3000	18.5	50.5	35.0
CR26500SL	C	3.0	5000	1.0	2000	3000	26.2	50.0	62.0
CR34615SL	D	3.0	11000	10.0	2000	3000	34.2	61.5	125.0
CR-P2SL	—	6.0	1500	1.0	1500	3000	35.8X19.5X34.8		42.0

Operation Temperature: -40 ~ +85°C, Self-Discharge Rate: 1%/year at room temperature.



High Capacity Bobbin Structure

Model	Size	Nominal Voltage (V)	Nominal Capacity (mAh)	Standard Discharge Current (mA)	Max. Discharge Current (mA)		Dimension (mm)		Approx. Weight (g)
					Conts.	Pulse	Diameter	Height	
CR14250BL	1/2AA	3.0	900	0.5	7	70	14.5	25.0	11.0
CR14335BL	2/3AA	3.0	1100	0.5	8	80	14.5	33.5	16.0
CR14505BL	AA	3.0	1800	1.0	10	100	14.5	50.5	22.0
CR17335BL	2/3A	3.0	1800	1.0	10	100	17.0	34.5	22.0
CR17450BL	—	3.0	2400	1.0	15	150	17.0	45.0	28.0
CR18505BL	—	3.0	3000	1.0	20	200	18.5	50.5	38.0

Operation Temperature: -40 ~ +85°C, Self-Discharge Rate: 1%/year at room temperature.

Electrical Performance Characteristics

High Power Type

(For CR14505SL Typical)

Discharge Characteristics

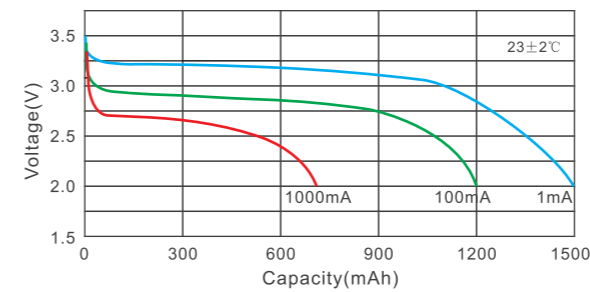

Voltage Vs. Temperature Characteristics

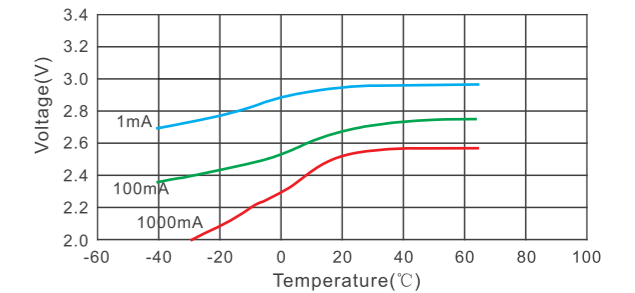

New Battery Vs. Stock Battery

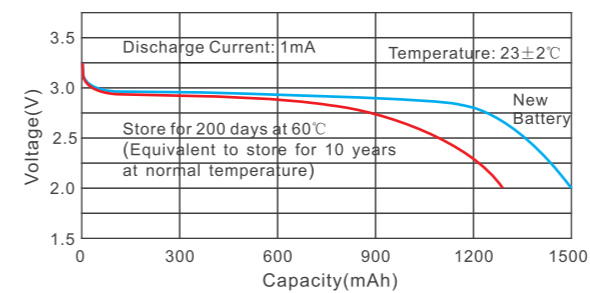

High Capacity Type

(For CR14505BL Typical)

Discharge Characteristics

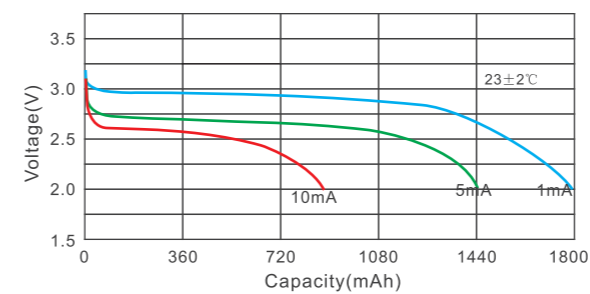

Voltage Vs. Temperature Characteristics

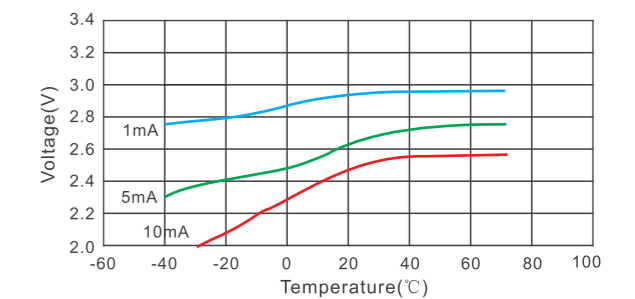

New Battery Vs. Stock Battery

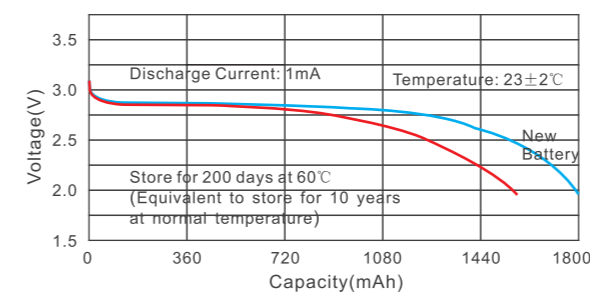

Li-MnO₂ Coin Battery

Cell Constructions

Positive reaction: $MnO_2 + Li^+ + e^- \rightarrow MnO_2Li$
 Negative reaction: $Li \rightarrow Li^+ + e^-$
 Total reaction: $MnO_2 + Li \rightarrow MnO_2Li$

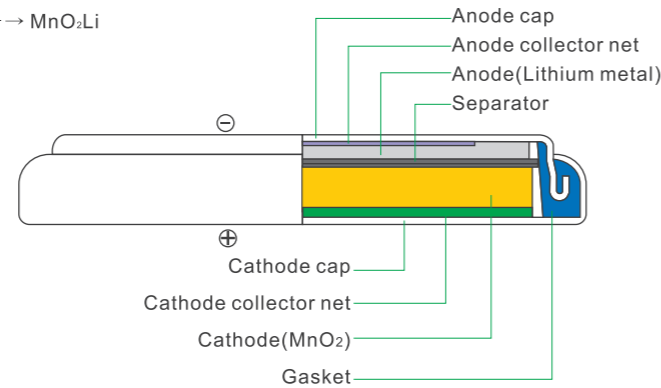

Main Features

- ▶ Low self-discharge rate and long shelf life.
Self-discharge rate: less than 3% a year at room temperature.
- ▶ Stable discharge characteristics.
- ▶ Superior high-rate pulse discharge characteristics.
- ▶ Applicable in a wide temperature range.
- ▶ Superior leakage resistance.

Applications

- ✔ TPMS (Tire-Pressure monitoring systems)
- ✔ ETCs (Electronic toll collection systems)
- ✔ Communication tags
- ✔ Set-top boxes
- ✔ Notebook PCs, Desktop PCs, Bluetooth headsets
- ✔ Medical instruments
- ✔ Cash registers
- ✔ Beacons
- ✔ FA Instruments (Measuring instruments, on-board microcomputers, sensors,)



Standard Type

Model	Nominal Voltage (V)	Nominal Capacity (mAh)	Standard Discharge Current (mA)	Dimension (mm)		Approx. Weight(g)
				Diameter	Height	
CR1220	3.0	40	0.2	12.5	2.0	0.8
CR1225	3.0	50	0.2	12.5	2.5	1.0
CR1616	3.0	50	0.1	16.0	1.6	1.2
CR1620	3.0	70	0.1	16.0	2.0	1.3
CR1632	3.0	120	0.1	16.0	3.2	1.6
CR2016	3.0	85	0.2	20.0	1.6	1.7
CR2025	3.0	150	0.4	20.0	2.5	2.4
CR2032	3.0	210	0.2	20.0	3.2	3.0
CR2330	3.0	250	0.4	23.0	3.0	4.0
CR2354	3.0	500	0.4	23.0	5.4	5.7
CR2430	3.0	270	0.4	24.5	3.0	4.3
CR2450	3.0	550	0.4	24.5	5.0	6.2
CR2477	3.0	1000	2.0	24.5	7.7	9.5

Operation Temperature: -20 ~ + 60°C, Self-Discharge Rate: < 3%/year at room temperature.

High Temperature Type

CR1632S	3.0	110	0.1	16.0	3.2	2.0
CR2025S	3.0	150	0.2	20.0	2.5	2.5
CR2032S	3.0	210	0.2	20.0	3.2	3.0
CR2450S	3.0	550	0.2	24.5	5.0	6.8

Operation Temperature: -40 ~ + 125°C, Self-Discharge Rate: < 5%/year at room temperature.

Low Temperature Type

CR1632L	3.0	120	0.2	16.0	3.2	2.0
CR2032L	3.0	210	0.2	20.0	3.2	3.0
CR2450L	3.0	580	0.4	24.5	5.0	6.8

Operation Temperature: -40 ~ + 70°C, Self-Discharge rate: < 5%/year at room temperature.

High Capacity Type

CR2032H	3.0	230	0.2	20.0	3.2	3.0
CR2450H	3.0	600	0.4	24.5	5.0	6.5

Operation Temperature: -20 ~ + 60°C, Self-Discharge Rate: < 3%/year at room temperature.

Electrical Performance Curve (For CR2025 Typical)

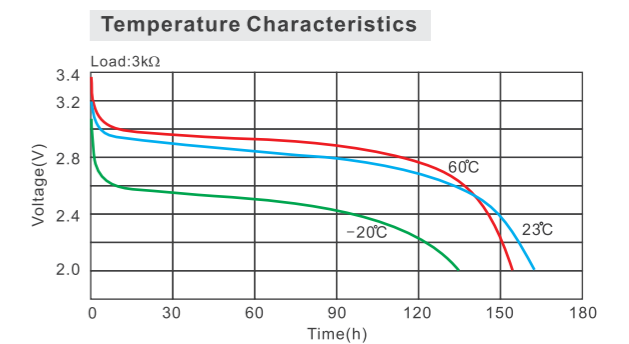
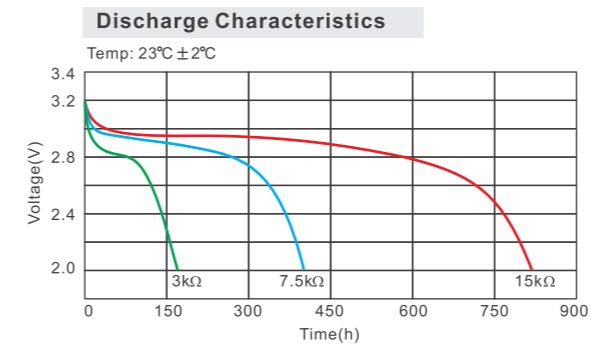

Li-Polymer Battery Rechargeable

🔊 Lithium Ion Polymer Battery Theory

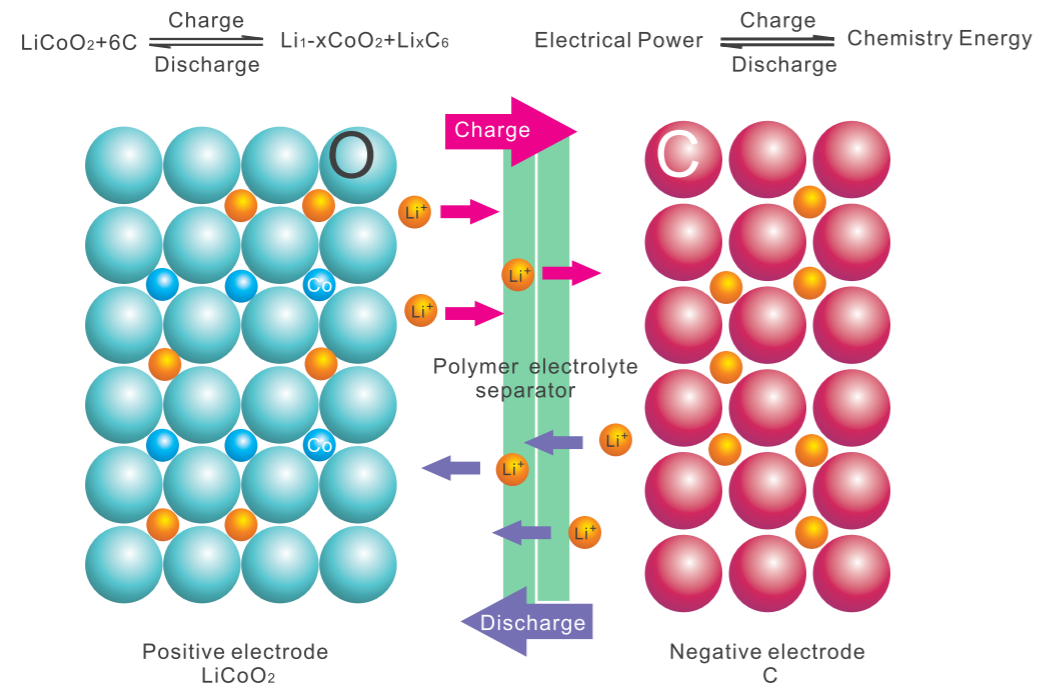

🔊 Cell Constructions

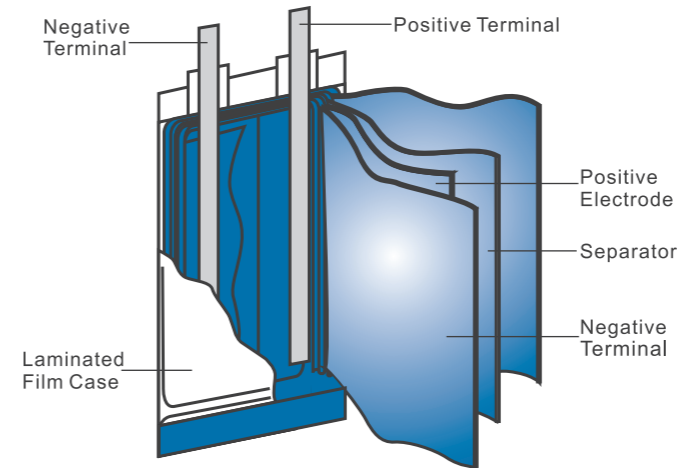

Positive: Pre-lithiated transition metal oxides, such as lithium cobalt oxide, lithium manganese oxide and etc.

Negative: carbon materials with special structures, such as soft carbon, hard carbon graphite and graphite carbon fibers and etc.

Electrolyte: organic solvents and lithium salt solution.

Separator: porous polypropylene (PP) or polyethylene(PE)

Packaging materials: aluminum composite film, steel casing or aluminum casing.

🔊 Main Features

- ▶ Excellent high power discharge
- ▶ Extremely safe
- ▶ Long cycle life
- ▶ Design flexible
- ▶ Lighter & thinner
- ▶ Low self-discharge rate
- ▶ Environmentally friendly

🔊 Applications

- ✓ Monitoring, Tracking units
- ✓ Telematics
- ✓ Wearable Electronic Devices
- ✓ PDA, Digital Cameras
- ✓ Bluetooth, Wireless Devices
- ✓ Electric Bicycle, Power Tools

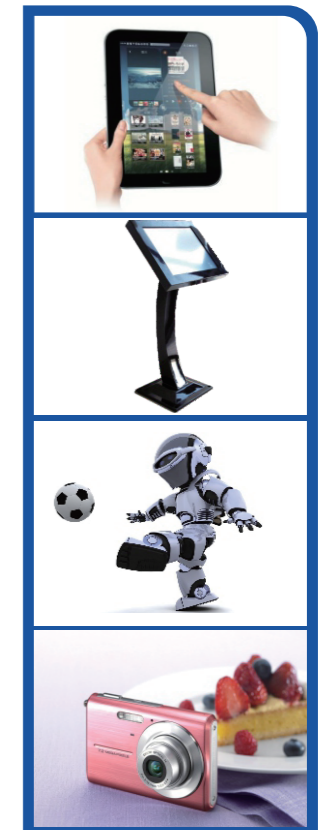
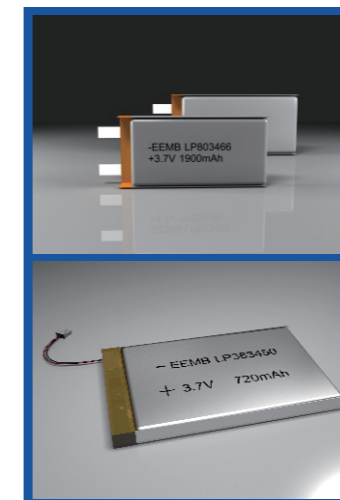

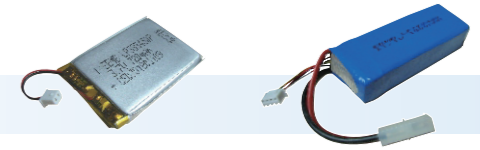

Product Specification

Standard Version							
Model	Nominal Voltage (V)	Nominal Capacity(mAh)		Dimension (mm)			Approx. Weight(g)
		Typical	Minimum	Thickness	Width	Height	
LP451124	3.7	65	55	4.8	11.5	26	1.3
LP401230	3.7	100	90	4.3	12	30	2.0
LP501230	3.7	140	130	5.3	12.5	31	2.8
LP301730	3.7	100	90	3.5	17.5	31	2.0
LP401730	3.7	150	140	4.3	17.5	31	3.0
LP601730	3.7	260	240	6.3	17.5	31	5.2
LP401745	3.7	250	230	4.3	17.5	46	5.0
LP402030	3.7	190	180	4.3	20.5	31	3.1
LP452030	3.7	230	210	4.8	20.5	31	4.6
LP502030	3.7	250	230	5.3	20.5	31	5.0
LP222036	3.7	95	90	2.5	20.5	37	1.9
LP402036	3.7	220	200	4.3	20.5	37	4.4
LP502036	3.7	310	280	5.3	20.5	37	6.2
LP552036	3.7	360	330	5.8	20.5	37	7.2
LP852040	3.7	620	580	8.8	20.5	41	12.4
LP822245	3.7	750	700	8.5	22.5	46	15.0
LP652438	3.7	540	500	6.8	24.5	39	10.8
LP752438	3.7	600	550	7.8	24.5	39	12.0
LP603026	3.7	420	400	6.3	30.5	27	8.4
LP653042	3.7	820	760	6.8	30.5	43	16.4
LP453048	3.7	710	650	4.8	30.5	49	14.2
LP503048	3.7	700	650	5.3	30.5	49	14.0
LP603048	3.7	900	800	6.3	30.5	49	18.0
LP703048	3.7	1000	950	7.3	30.5	49	20.0
LP803048	3.7	1200	1100	8.3	30.5	49	24.0
LP883048	3.7	1300	1200	9.1	30.5	49	26.0
LP803090	3.7	2300	2200	8.3	30.5	91	46.0
LP883090	3.7	2700	2600	9.1	30.5	91	54.0
LP403448	3.7	620	580	4.3	34.5	49	12.4
LP503448	3.7	880	830	5.3	34.5	49	17.6
LP603448	3.7	1000	950	6.3	34.5	49	21.0
LP803448	3.7	1350	1250	8.0	34.5	49	27.0
LP293450	3.7	450	420	3.5	34.5	51	9.0
LP323450	3.7	550	500	3.5	34.5	51	11.0
LP383450	3.7	720	670	4.1	34.5	51	14.4
LP483450	3.7	800	750	5.1	34.5	51	16.0
LP503450	3.7	1000	900	5.3	34.5	51	20.0
LP533450	3.7	900	850	5.6	34.5	51	18.0
LP603450	3.7	1100	1000	6.3	34.5	51	22.0
LP703450	3.7	1250	1150	7.3	34.5	51	25.0
LP803450	3.7	1400	1300	8.3	34.5	51	28.0
LP953450	3.7	1800	1700	9.8	34.5	51	36.0
LP963450	3.7	1800	1700	9.9	34.5	51	36.0
LP243452	3.7	350	330	2.7	34.5	55	7.0
LP383454	3.7	750	700	4.1	34	55	15.0
LP103454	3.7	2000	1900	10.3	34.5	55	40.0
LP603560	3.7	1300	1200	6.3	35.5	61	26.0
LP503759	3.7	1200	1100	5.0	37.5	60	24.0

Standard Version							
Model	Nominal Voltage (V)	Nominal Capacity(mAh)		Dimension (mm)			Approx. Weight(g)
		Typical	Minimum	Thickness	Width	Height	
LP583759	3.7	1350	1250	6.1	37.5	60	27.0
LP404261	3.7	1000	950	4.3	42.5	62	20.0
LP754261	3.7	2000	1900	7.8	42.5	62	40.0
LP704374	3.7	2200	2100	7.0	43.5	75	50.0
LP704765	3.7	2400	2300	7.3	47.5	66	48.0
LP804765	3.7	2600	2500	8.3	47.5	66	52.0
LP884765	3.7	3000	2800	9.1	47.5	66	60.0
LP385085	3.7	1600	1500	4.1	50.5	86	32.0
LP505085	3.7	2300	2200	5.3	50.5	86	46.0
LP705085	3.7	3500	3300	7.3	50.5	86	70.0
LP9051109	3.7	5000	4700	9.3	51.5	110	100.0
LP9551119	3.7	6800	6500	9.8	51.5	120	136.0
LP555255	3.7	1650	1550	5.8	52.5	56	33.0
LP305590	3.7	1450	1350	3.7	55.5	91	29.0
LP385590	3.7	1900	1800	4.1	55.5	91	38.0
LP505590	3.7	2800	2700	5.3	55.5	91	56.0
LP545590	3.7	2900	2800	5.7	55.5	91	58.0
LP605590	3.7	3400	3200	6.3	55.5	91	68.0
LP61100100	3.7	6800	6400	6.4	100.5	101	136.0
LP38103122	3.7	5200	4900	4.1	103.5	123	104.0
LP70103122	3.7	8700	8300	7.3	103.5	123	174.0

Operation Temperature:-20 ~ + 60°C.

*Thickness can be adjusted while the length and width remain the same.

Electrical Performance Curve (For LP703048 Typical)

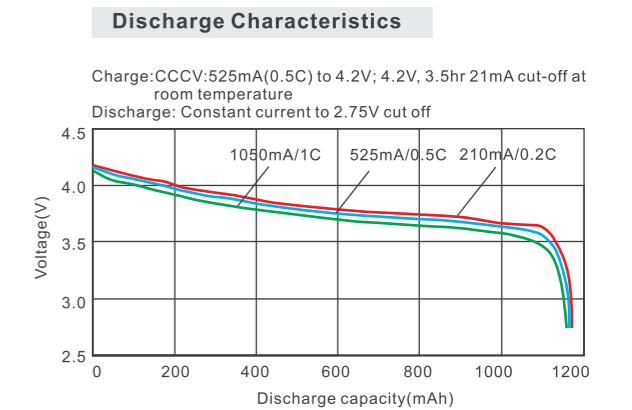
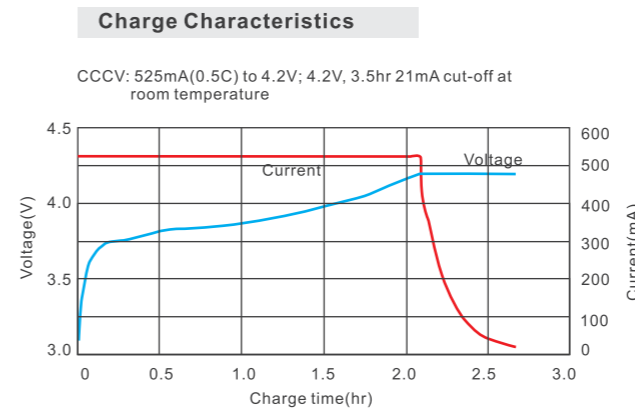

LiFePO₄ Battery Rechargeable

Cell Constructions

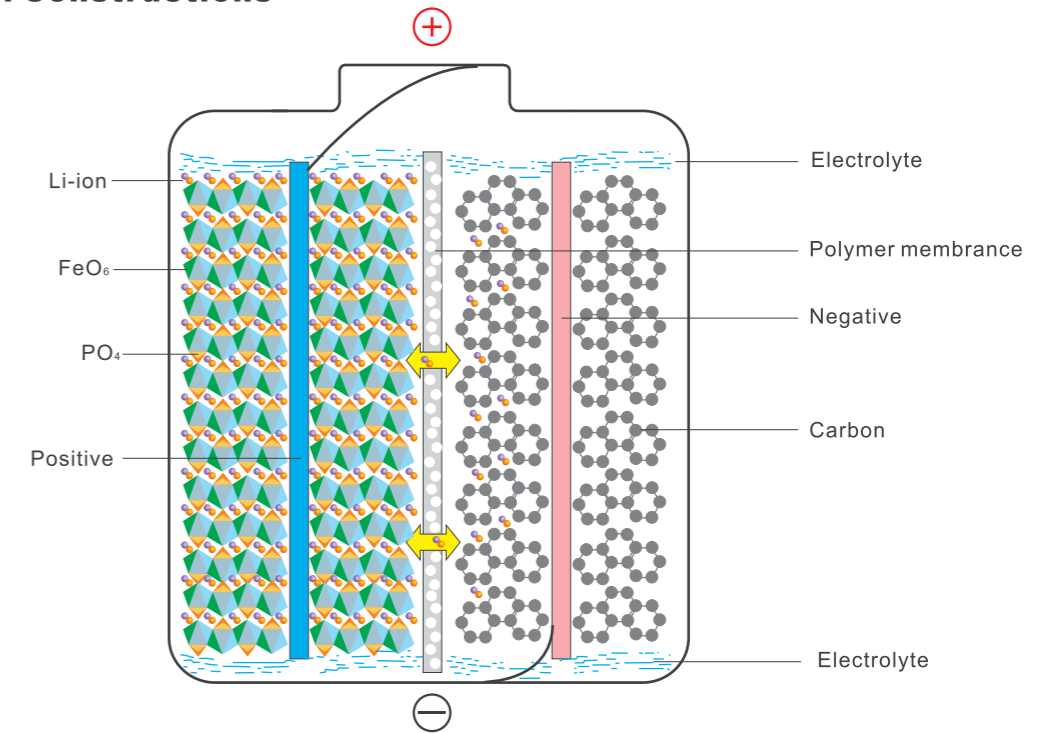

Lithium Iron Phosphate Battery Theory

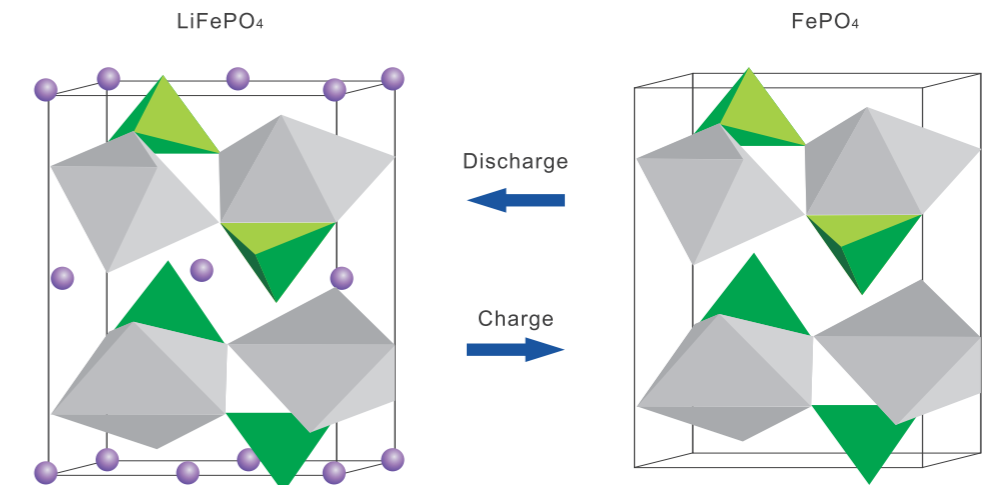

High Rate Discharge Version							
Model	Nominal Voltage (V)	Nominal Capacity(mAh)		Dimension (mm)			Approx. Weight(g)
		Typical	Minimum	Thickness	Width	Height	
LP452030HA	3.7	160	140	4.5	20	30	4.5
LP353048HA	3.7	400	350	3.8	30.5	49	8.0
LP403048HA	3.7	400	380	4.0	30	48	10.0
LP423048HA	3.7	430	390	4.2	30	48	28.5
LP503048HA	3.7	550	500	5.3	30.5	49	11.0
LP703048HA	3.7	800	750	7.0	30	48	19.0
LP883090HA	3.7	2000	1900	8.8	30	90	45.5
LP553448HA	3.7	800	750	5.8	34.5	49	16.0
LP603450HA	3.7	880	830	6.0	34	50	13.5
LP803454HA	3.7	1400	1300	8.3	34.5	55	28.0
LP803560HA	3.7	1250	1150	8.0	35	60	30.5
LP503759HA	3.7	850	800	5.0	37	59	22.0
LP451218HB	3.7	40	39	4.7	12.5	19	1.1
LP555590HB	3.7	2300	2200	5.5	55	90	54.5
LP723048HB	3.7	800	784	7.0	30	48	19.0
LP532030HB	3.7	200	180	5.8	20.5	32.5	7.0
LP551522HB	3.7	100	90	6.0	15.5	23	3.4
LP681723HB	3.7	150	143	7.3	17.5	26	4.8
LP481530HC	3.7	120	110	4.8	15	30	3.3
LP753496HC	3.7	2200	2150	7.8	34.5	98	48.5
LP3834106HD	3.7	1200	1100	3.8	34	106	29.0
LP8242125HD	3.7	4000	3800	8.2	42	125	91.0
LP9245150HD	3.7	5550	5400	9.2	45	150	111.0
LP1042126HD	3.7	5000	4750	10.0	43	127	116
LP7842125HD	3.7	3700	3650	7.8	42	125	88.0

Operation Temperature: -20 ~ + 60°C.

- ※ HA: 5 C-10 C Continuous Discharge
- ※ HB: 10 C-15 C Continuous Discharge
- ※ HC: 15 C-20 C Continuous Discharge
- ※ HD: 20 C Continuous Discharge

High & Low Temperature Version							
Model	Nominal Voltage (V)	Nominal Capacity(mAh)		Dimension (mm)			Approx. Weight(g)
		Typical	Minimum	Thickness	Width	Height	
LP383454LC	3.7	720	680	4.1	34.5	55	14.4
LP603048LC	3.7	900	850	6.3	30.5	49	18.0
LP963450LC	3.7	1800	1700	9.9	34.5	51	36.0
LP103450LC	3.7	1850	1800	10.3	34.5	51	37.0
LP505597LC	3.7	3100	3000	5.3	55.5	98	62.0
LP103454LC	3.7	2000	1950	10.3	34.5	55	40.0
LP102040TB	3.7	800	750	10.3	20.5	41	16.0

LC: Operation Temperature -40 ~ 55°C. TB: Operation Temperature -20 ~ 70°C.

*Thickness can be adjusted while the length and width remain the same.

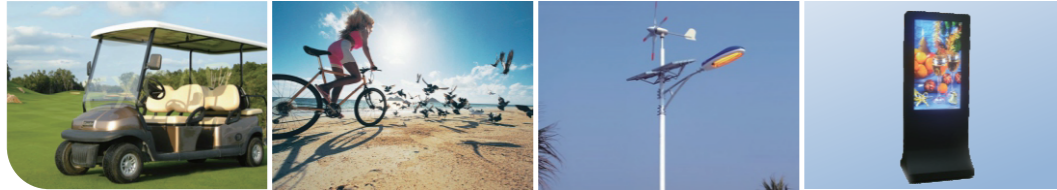

Electrical Performance Characteristics

Cycle Life Characteristics

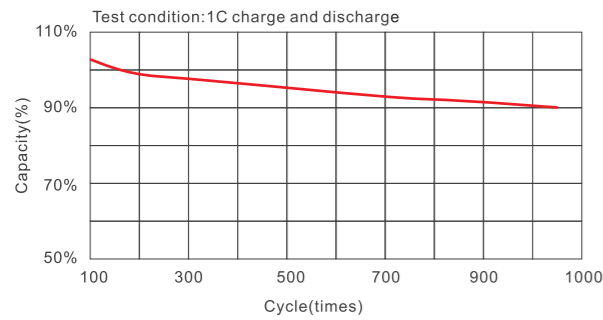

Charge & Discharge Characteristics

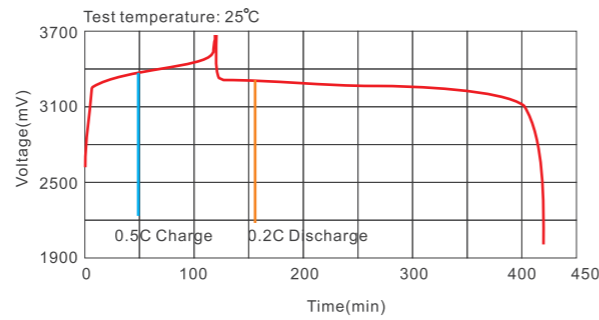

Main Features

- ▶ **Long cycle life: more than 2000 times**
Charge and discharge at 1C, 80% capacity retention after 2000 cycles.
- ▶ **High safety**
- ▶ **Excellent charging and discharging performance**
- ▶ **High discharge rate up to 10C**
- ▶ **Environmentally friendly**
No poisonous or hazardous materials, no pollution to the environment.

Applications

- ✔ **Light Electric Vehicles**
E-bike, Golf cart, Minitype panel scooter, Forklift, Cleaning vehicle, Electric-wheel chair.
- ✔ **Energy Storage Equipment for Solar Energy and Wind Energy**
- ✔ **Electric Tools**
Electric drill, Electric saw, Electric lawn mower, UPS, Emergency lamp, Caution light and miner's light (Best safety)
- ✔ **Electric Vehicles**
Tourist bus and hybrid vehicle.
- ✔ **Mobile Telecommunication Base Station**
- ✔ **Emergency Power Supply System**

Cell

Model	Nominal Voltage (V)	Nominal Capacity (mAh)	Dimension(mm) max.			Approx. Weight(g)
			Thickness	Width	Height	
LP903395F	3.2	2000	9.3	33.5	97	40.0
LP584374F	3.2	1300	6.1	43.5	75	32.5
LP904374F	3.2	2100	9.3	43.5	75	52.5
LP7851119F	3.2	3500	8.1	51.5	120	87.5
LP9051119F	3.2	4300	9.3	51.5	121	107.5
LP7053140F	3.2	4000	7.3	53.5	142	100.0
LP5267220F	3.2	6000	5.5	67.5	222	150.0
LP1167220F	3.2	11000	11.3	67.5	224	275.0
LP7568130F	3.2	5000	7.8	68.5	131	125.0
LP9590120F	3.2	7500	9.8	90.5	122	187.5
LP8867220F	3.2	10000	9.3	67.5	224	250.0
LP60100100F	3.2	4500	6.3	100.5	101	112.5
LP90100160F	3.2	10000	9.5	101.0	166	250.0
LP75103122F	3.2	7000	7.8	103.5	123	175.0
LP13120215F	3.2	25000	14.0	122.0	225	750.0

Models Listed are all UL Certificated and have ready mold.

Pack

Model	Nominal Voltage (V)	Nominal Capacity (mAh)	Cell Dimension(mm) max.			Approx. Pack Weight (kg)
			Thickness	Width	Height	
LP8867220F-4S	12.8	10000	9.3	67.5	224	1.5
LP8867220F-2P4S	12.8	20000	9.3	67.5	224	2.5
LP8867220F-4P4S	12.8	40000	9.3	67.5	224	4.5
LP8867220F-8S	25.6	10000	9.3	67.5	224	2.5
LP8867220F-2P8S	25.6	20000	9.3	67.5	224	4.5
LP8867220F-6P16S	51.2	60000	9.3	67.5	224	25.0
LP8867220F-2P20S	64	20000	9.3	67.5	224	11.0
LP8867220F-4P20S	64	40000	9.3	67.5	224	22.0

Module

Model	Nominal Voltage(V)	Nominal Capacity (mAh)	Dimension(mm) max.			Approx. Weight(kg)
			Thickness	Width	Height	
3.2V, 40Ah	3.2	40000	60	95	280	2.00
3.2V, 80Ah	3.2	80000	60	165	280	3.25
3.2V, 100Ah	3.2	100000	71	160	280	3.75

Cylindrical

Model	Nominal Voltage(V)	Nominal Capacity (mAh)	Internal Impedance (mΩ)	Dimension(mm) max.		Approx. Weight(g)
				Diameter	Height	
LIP14500	3.2	600	≤40	14.0	50.0	17
LIP18500	3.2	1000	≤60	18.1	48.8	37
LIP18650	3.2	1100	≤20	18.0	65.0	41
LIP18650	3.2	1400	≤60	18.0	65.0	40
LIP26650	3.2	3200	≤50	26.5	66.0	90

Operation Temperature:-10 ~ + 60°C.

Li-ion Battery Rechargeable

Cell Constructions and Theory

Cylindrical Type Battery

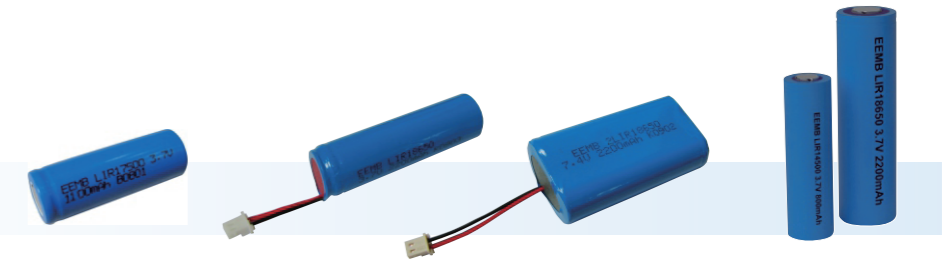
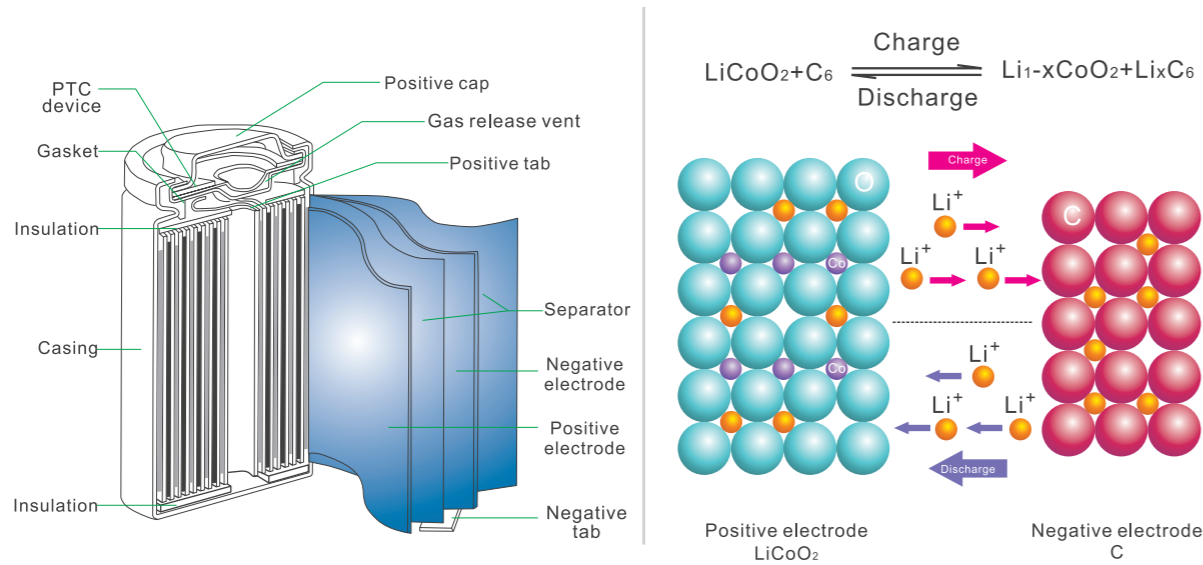

Cylindrical Type

Model	Nominal Voltage (V)	Nominal Capacity (mAh)	Internal Impedance (mΩ)	Dimension (mm)		Approx. Weight(g)
				Diameter	Height	
LIR10440	3.7	300	≤80	10.5	44.5	10.0
LIR14500	3.7	800	≤80	14.3	52.5	21.0
LIR17500	3.7	1100	≤80	17.5	50.5	29.0
LIR18500	3.7	1500	≤70	18.0	50.0	33.0
LIR18500	3.7	1400	≤70	18.5	50.0	33.0
LIR18650	3.7	2000	≤60	18.5	65.5	45.0
LIR18650	3.7	2200	≤80	18.6	65.3	47.0
LIR18650	3.7	2600	≤60	18.6	65.3	45.5
LIR18650	3.7	3000	≤60	18.0	65.0	46.5

Prismatic Type

Model	Nominal Voltage (V)	Nominal Capacity (mAh)	Internal Impedance (mΩ)	Dimension (mm)			Approx. Weight(g)
				Thickness	Width	Length	
LIR103450A	3.7	1800	≤60	10.5	34.0	50.0	35.5
LIR043048A	3.7	600	≤60	4.4	30.0	47.8	14.5
LIR523443A	3.7	880	≤80	5.5	34.0	43.0	18.1

*Battery pack can be customized according to customer's requirements.

Main Features

- ▼ **Compact and slim**
 Its high energy density helps design smaller and lighter equipment such as notebooks which consume higher power.
- ▼ **Long operating time**
 Its graphite negative electrode enables the battery pack to operate equipment for a long time with stable platform voltage.

Applications

- ✓ Tracking units
- ✓ Laptop computers
- ✓ Monitoring units
- ✓ Wearable electronics devices
- ✓ Communication devices
- ✓ Digital cameras
- ✓ Electronic instruments
- ✓ Office automation
- ✓ Audio visual equipment
- ✓ PDA and handy terminals





Coin Type							
Model	Nominal Voltage (V)	Nominal Capacity (mAh)	Recommended Current(mA)		Approx Dimension (mm)		Approx. Weight(g)
			Conts.	Pulse	Diameter	Height	
LIR1050	3.7	27	0.2CmA	1CmA	10.5	5.0±0.1	1.16
LIR1220	3.7	9			12.5	2.0±0.2	0.82
LIR1248	3.7	45			12.5	4.8±0.1	1.68
LIR1255	3.7	60			12.5	5.5±0.3	2.00
LIR1448	3.7	65			14.5	4.8±0.1	2.20
LIR1455	3.7	80			14.5	5.5±0.5	2.60
LIR1620	3.7	20			16.0	2.0±0.2	1.35
LIR1632	3.7	30			16.0	3.2±0.1	1.75
LIR1655	3.7	110			16.0	5.5±0.5	3.35
LIR2016	3.7	20			20.0	1.6±0.4	1.80
LIR2025	3.7	40			20.0	2.5±0.2	2.50
LIR2032	3.7	45			20.0	3.2±0.2	2.60
LIR2430	3.7	95			24.5	3.0±0.2	4.20
LIR2440	3.7	145			24.5	4.0±0.2	5.60
LIR2450	3.7	120			24.5	5.0±0.2	5.30
LIR2477	3.7	200			24.5	7.7	7.50
LIR3032	3.7	180	30.0	3.2±0.2	7.10		
LIR3048	3.7	280	30.0	4.8±0.1	9.40		
High Capacity Type							
LIR2032H	3.7	70	0.2CmA	1CmA	20.0	3.2±0.2	3.15
LIR2450H	3.7	200			24.5	5.0±0.2	6.92

Operation Temperature:-20 ~ + 60°C.



Available Terminals For button batteries

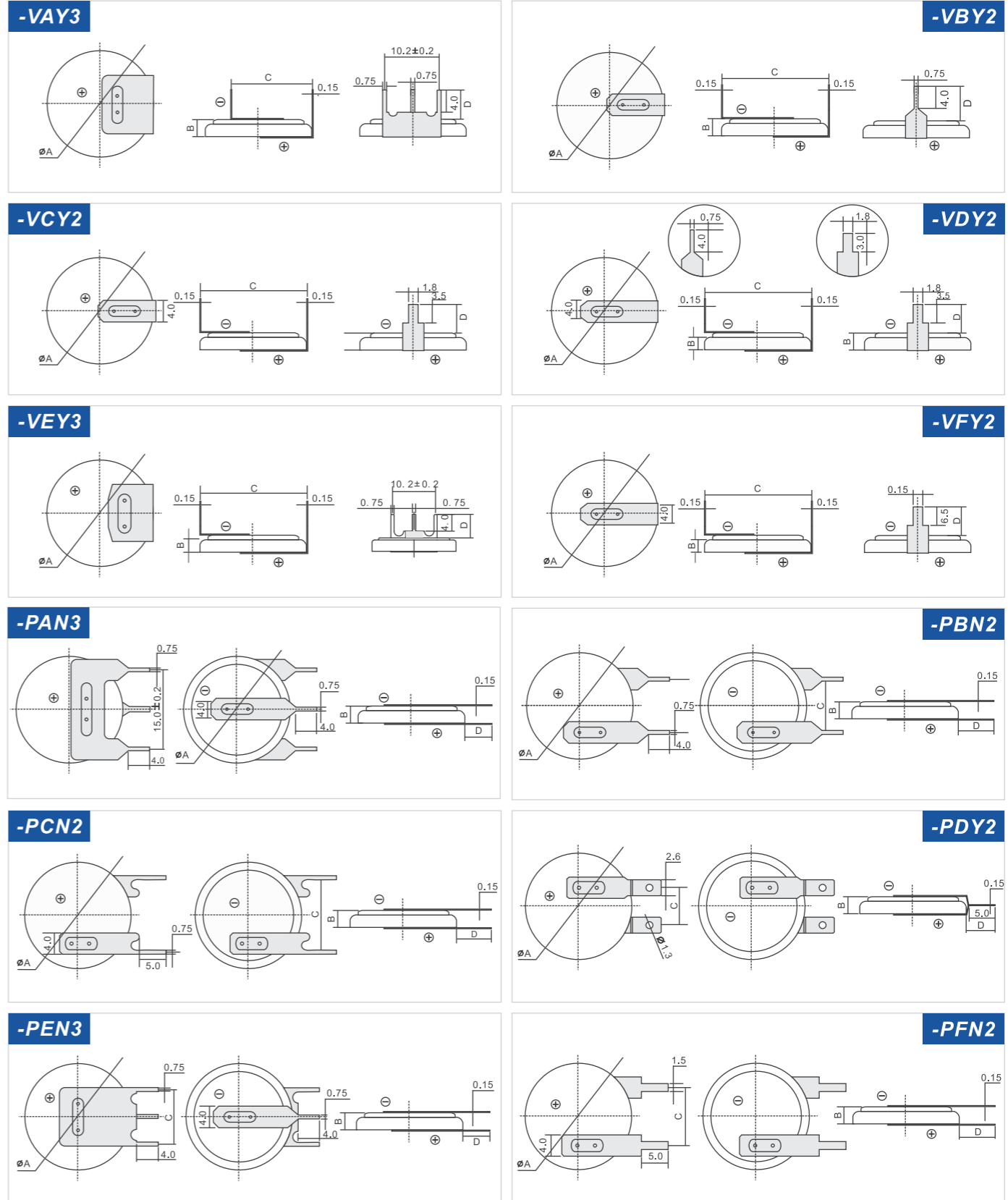

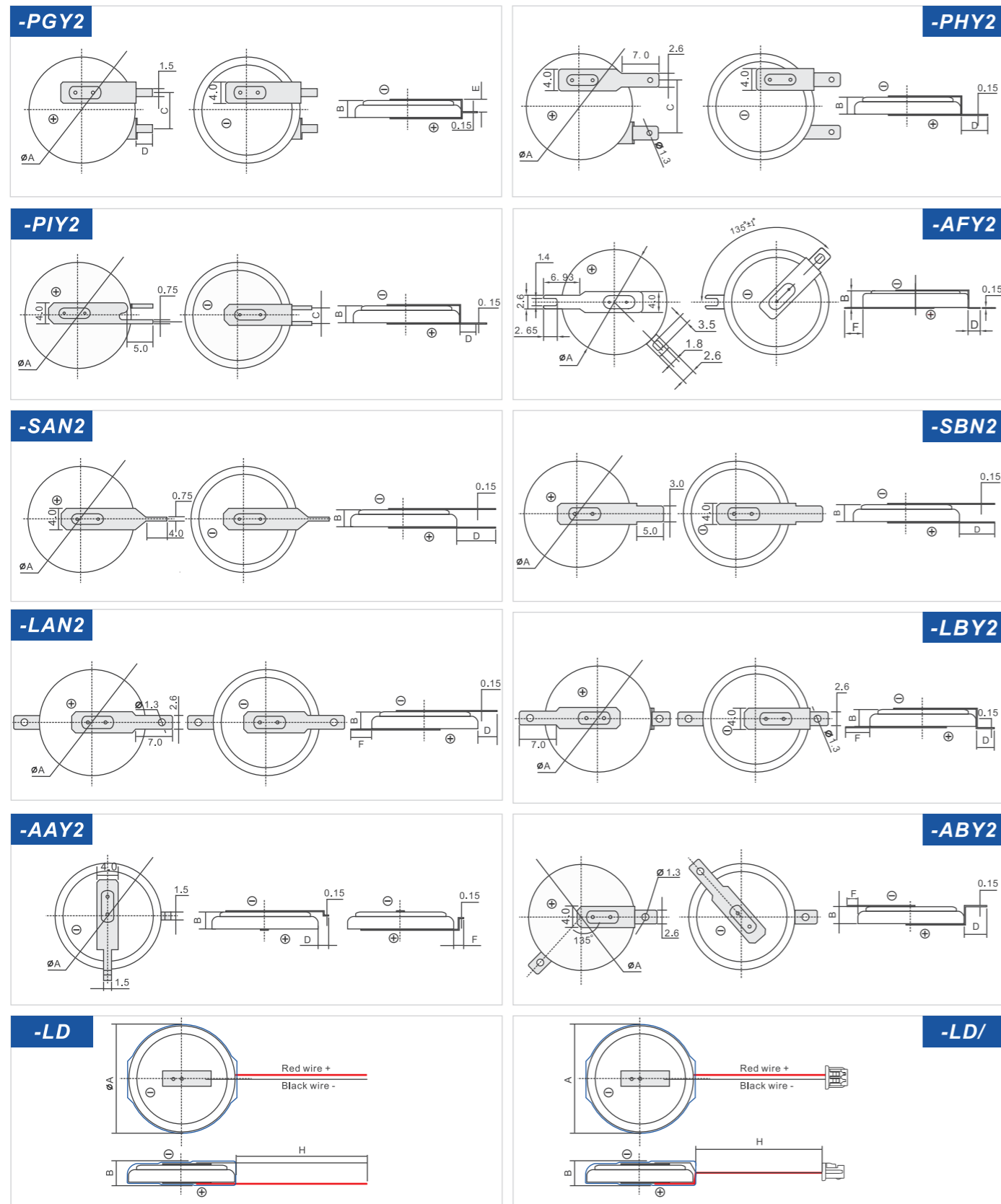

Remark: Customized design is available

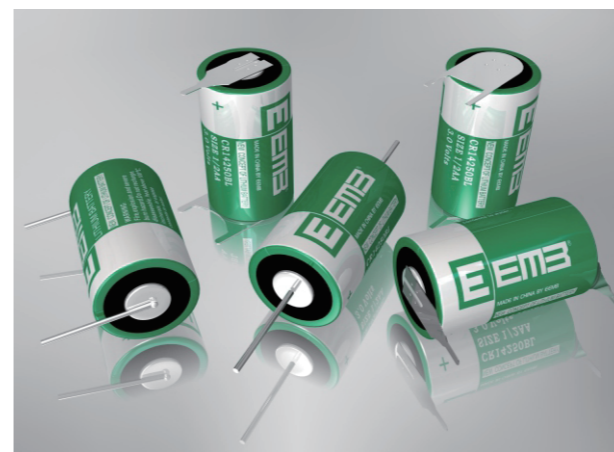
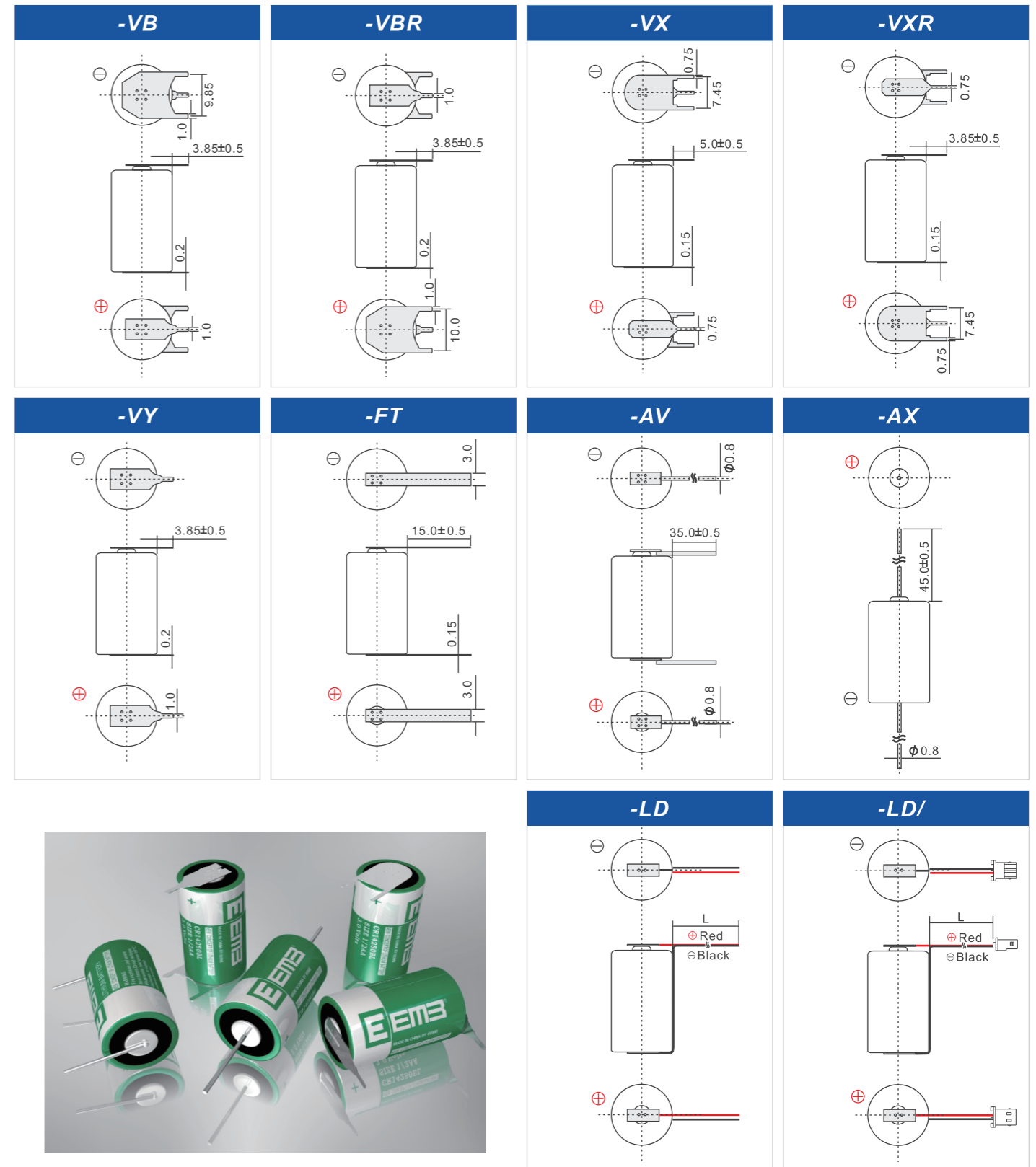

Battery Holder



For Button Batteries

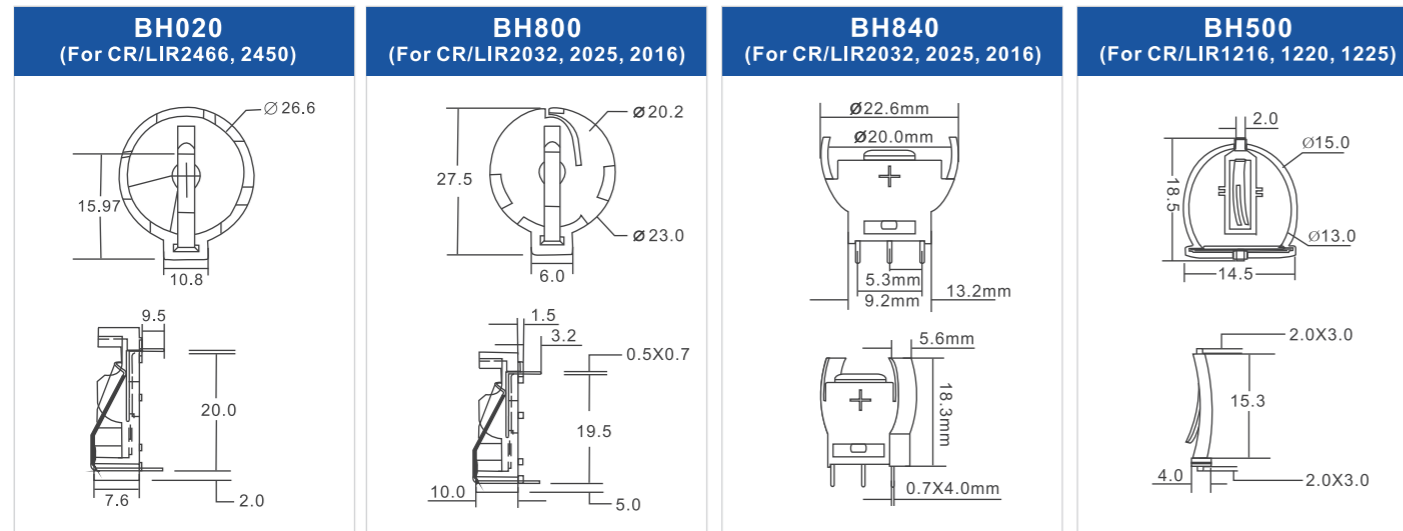

For Cylindrical Batteries

